

# High Current Cartridge Fuse Clips

## 124 Series > For For 10x38mm & 3AG/3AB Fuses



### Product Characteristics

Compatible Fuse Size	10mm Diameter Fuses		6.3 mm Diameter Fuse	
	124 040	124 041	124 060	124 061
Fuse Clip				
Current Level	63 Amperes Max.		40 Amperes Max.	

**Note:** Fuseclips were developed for High current fuses (606/688 Series). Fuseclips also can be used according to size described, for 10x38mm & 3AG/3AB diameter fuses.

### Features and Benefits

- RoHS compliant and Lead-free
- UL recognized to UL 4248-1 and CSA 4248.1
- Designed for high-current applications, up to 63 Amp
- Designed for applications with PC boards, also suitable for rivet installation
- Higher current ratings attained using high performance Cu alloy
- Compatible to varieties of applications using cartridge fuses
- Tin-plated leads for easy soldering process

### Additional Information



Resources



Accessories



Samples

### Agency Approvals

Agency	Agency File Number
	E14721

### Ordering Information

Part Number	Catalog No.	Clip Material	Plating	Style	Packaging
<b>Rivet/SMT Clip</b>					
01240040H	124040	Cu Alloy	Tin Plated with Nickel Undercoat	Ear	Bulk (100 pieces)
01240060H	124060	Cu Alloy	Tin Plated with Nickel Undercoat	Ear	Bulk (100 pieces)
<b>THT Clip</b>					
01240041H	124041	Cu Alloy	Tin Plated with Nickel Undercoat	Ear	Bulk (100 pieces)
01240061H	124061	Cu Alloy	Tin Plated with Nickel Undercoat	Ear	Bulk (100 pieces)

# High Current Cartridge Fuse Clips

## 124 Series > For For 10x38mm & 3AG/3AB Fuses

### Product Dimensions (in mm)

Note: Contact Littelfuse Team for different layout if the fuse size is different than specified

#### SMT/Panel Mount Clip - 124040

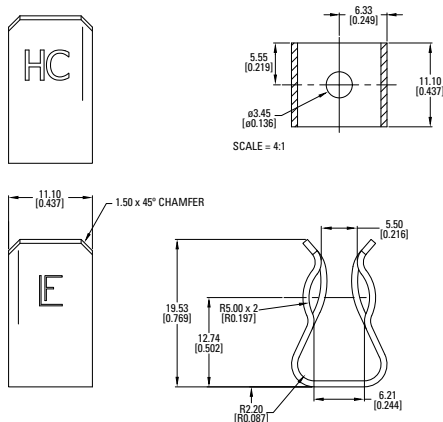

#### Mounting Details

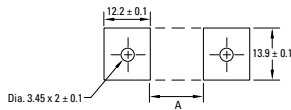

Fuse Size	A Dimension (mm)
10x38 mm	19.4 ± 0.1
10x32 mm	13.9 ± 0.1

#### THT Clip - 124061

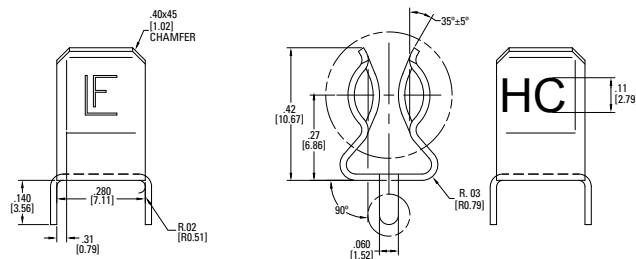

#### Mounting Details

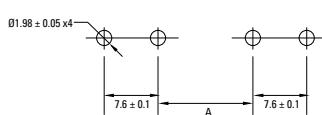

Fuse Size	A Dimension (mm)
6.3x32 mm	20.4 ± 0.1
6.3x25 mm	13.3 ± 0.1

#### SMT Clip - 124060

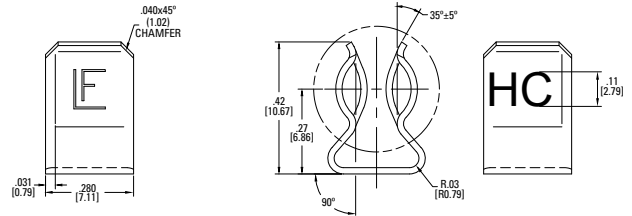

#### Mounting Details

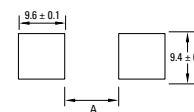

Fuse Size	A Dimension (mm)
6.3x32 mm	19.1 ± 0.1
6.3x25 mm	11.4 ± 0.1

#### THT Clip - 124041

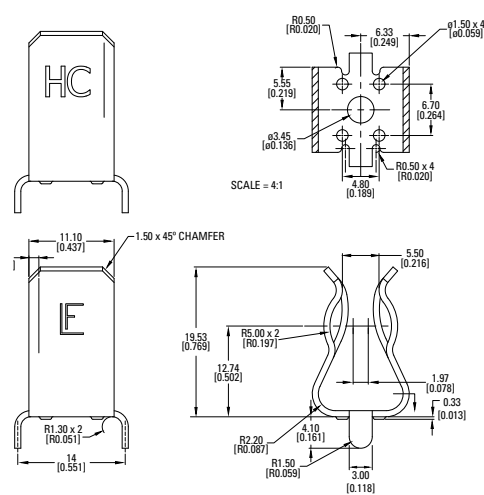

#### Mounting Details

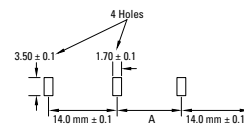

Fuse Size	A Dimension (mm)
10x38 mm	18.4 ± 0.1
10x32 mm	12.7 ± 0.1

### Soldering Parameters—Wave Soldering

Wave Parameter	Lead-Free Recommendation
<b>Preheat:</b> (Depends on Flex Activation Temperature)	(Typical Industry Recommendation)
Temperature Minimum	100 °C
Temperature Maximum	150 °C
Preheat Time	60–180 seconds
<b>Solder Pot Temperature</b>	260 °C Maximum
<b>Solder Dwell Time</b>	2–5 seconds

**Recommended Hand-Solder Parameters:**  
Solder Iron Temperature: 350 °C +/- 5 °C  
Heating Time: 5 seconds max.

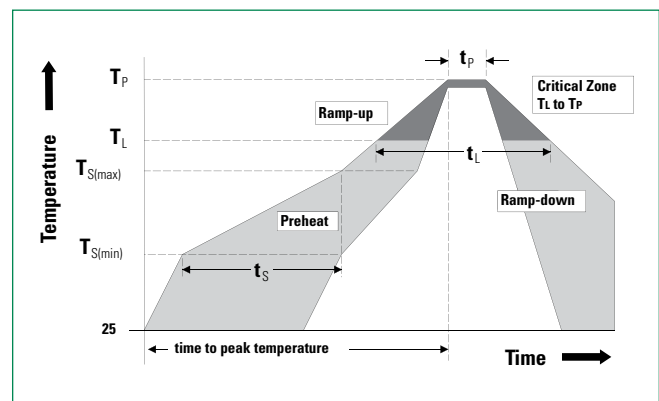

**Disclaimer Notice** - Information furnished is believed to be accurate and reliable. However, users should independently evaluate the suitability of and test each product selected for their own applications. Littelfuse products are not designed for, and may not be used in, all applications. Read complete Disclaimer Notice at <http://www.littelfuse.com/disclaimer-electronics>.