

# AQ3041 Series

## Low Capacitance ESD Protection



### Pinout

SOD882

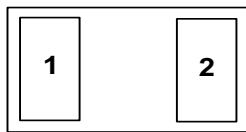

### Functional Block Diagram

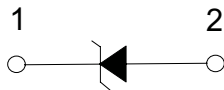

Life Support Note:

#### Not Intended for Use in Life Support or Life Saving Applications

The products shown herein are not designed for use in life sustaining or life saving applications unless otherwise expressly indicated.

### Description

The AQ3041 low capacitance rail to rail diode provides protection for electronic equipment that may experience destructive electrostatic discharges (ESD). This robust diode can safely absorb repetitive ESD strikes above the maximum level specified in IEC 61000-4-2 international standard ( $\pm 20\text{kV}$  contact discharge) without performance degradation. The low loading capacitance makes it ideal for protecting high speed data lines such as HDMI, DVI, USB2.0, USB3.0 and eSATA.

### Features

- ESD protection of  $\pm 20\text{kV}$  contact discharge,  $\pm 30\text{kV}$  air discharge, (IEC 61000-4-2)
- EFT protection, IEC 61000-4-4, 40A ( $t_p=5/50\text{ns}$ )
- Lightning, 3A (8/20 as defined in IEC 61000-4-5 2nd edition)
- PPAP capable
- Low capacitance of  $0.5\text{pF}$  @  $V_R=0\text{V}$
- Low leakage current of  $0.1\mu\text{A}$  at  $5\text{V}$
- Small SOD882 packaging helps save board space
- AEC-Q101 qualified
- Halogen free, lead free and RoHS compliant
- Moisture Sensitivity Level(MSL -1)

### Applications

- Tablets
- Ultrabook
- eReader
- Smart Phones
- Digital Cameras
- MP3/ PMP
- Set Top Boxes
- Portable Medical
- Automotive applications

### HDMI Application Example

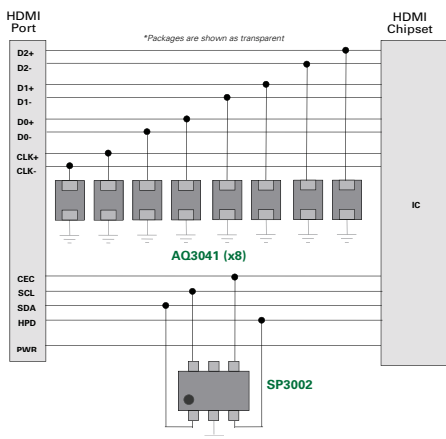

### USB3.0 Application Example

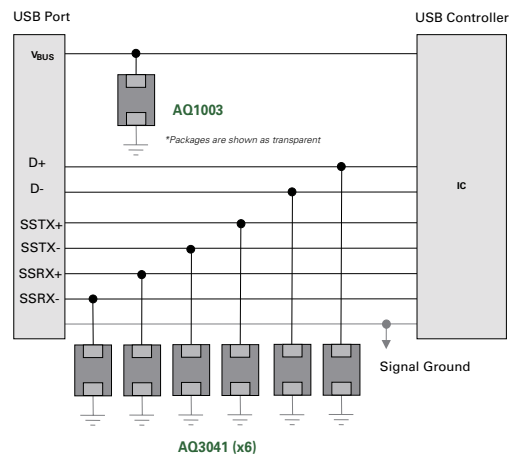

# AQ3041 Series

## Low Capacitance ESD Protection

### Absolute Maximum Ratings

Symbol	Parameter	Value	Units
$I_{PP}$	Peak Current ( $t_p=8/20\mu s$ )	3.0	A
$T_{OP}$	Operating Temperature	-40 to 150	°C
$T_{STOR}$	Storage Temperature	-55 to 150	°C

**Caution:** Stresses above those listed in "Absolute Maximum Ratings" may cause permanent damage to the component. This is a stress only rating and operation of the component at these or any other conditions above those indicated in the operational sections of this specification is not implied.

### Electrical Characteristics ( $T_{OP}=25^\circ C$ )

Parameter	Symbol	Test Conditions	Min	Typ	Max	Units
Reverse Standoff Voltage	$V_{RWM}$	IR=1 $\mu$ A	-	-	5	V
Reverse Leakage Current	$I_{LEAK}$	$V_R=5V$ with 1 pin at GND	-	0.1	0.5	$\mu$ A
Clamp Voltage <sup>1</sup>	$V_C$	$I_{PP}=1A$ , $t_p=8/20\mu s$ , Fwd	-	9.2	-	V
		$I_{PP}=2A$ , $t_p=8/20\mu s$ , Fwd	-	10.0	-	V
ESD Withstand Voltage <sup>1</sup>	$V_{ESD}$	IEC 61000-4-2 (Contact)	$\pm 20$	-	-	kV
		IEC 61000-4-2 (Air)	$\pm 30$	-	-	kV
Dynamic Resistance <sup>2</sup>	$R_{DYN}$	TLP, $t_p=100ns$ , I/O to GND	-	0.3	-	$\Omega$
Diode Capacitance <sup>1</sup>	$C_{I/O-GND}$	Reverse Bias=0V, f=1 MHz	-	0.5	-	pF

**Note:**

<sup>1</sup> Parameter is guaranteed by design and/or component characterization.

<sup>2</sup> Transmission Line Pulse (TLP) with 100ns width, 2ns rise time, and average window  $t_1=70ns$  to  $t_2=90ns$

### Normalized Capacitance vs. Reverse Voltage

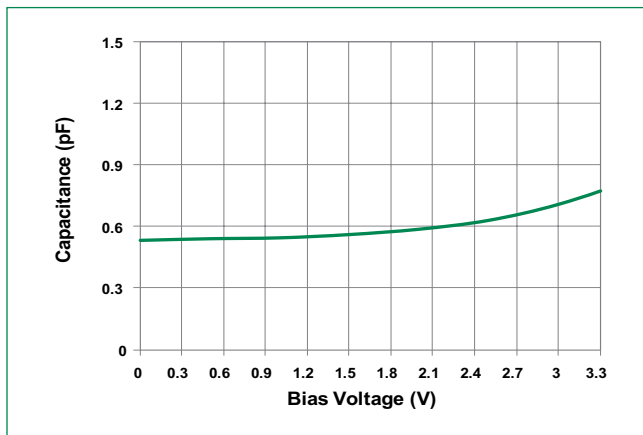

### 8/20 $\mu s$ Pulse Waveform

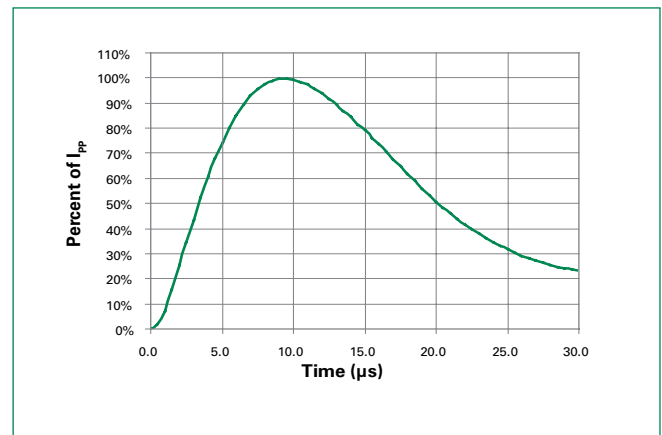

### Transmission Line Pulsing (TLP) Plot

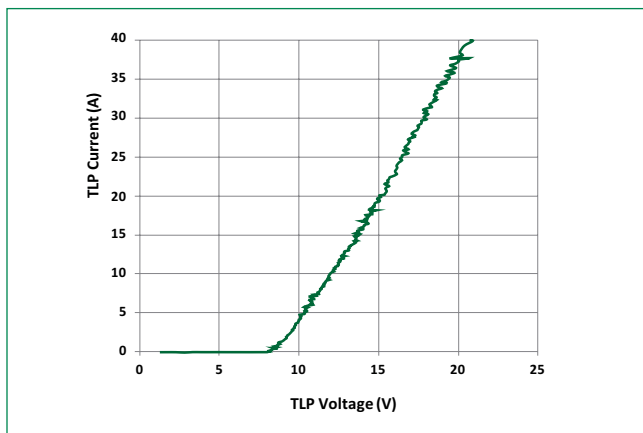

# AQ3041 Series

## Low Capacitance ESD Protection

### Soldering Parameters

<b>Reflow Condition</b>		Pb – Free assembly
<b>Pre Heat</b>	- Temperature Min ( $T_{s(min)}$ )	150°C
	- Temperature Max ( $T_{s(max)}$ )	200°C
	- Time (min to max) ( $t_s$ )	60 – 120 secs
<b>Average ramp up rate (Liquidus) Temp (<math>T_L</math>) to peak</b>		3°C/second max
<b><math>T_{s(max)}</math> to <math>T_L</math> - Ramp-up Rate</b>		3°C/second max
<b>Reflow</b>	- Temperature ( $T_L$ ) (Liquidus)	217°C
	- Temperature ( $t_l$ )	60 – 150 seconds
<b>Peak Temperature (<math>T_p</math>)</b>		260 <sup>+0/-5</sup> °C
<b>Time within 5°C of actual peak Temperature (<math>t_p</math>)</b>		30 seconds
<b>Ramp-down Rate</b>		6°C/second max
<b>Time 25°C to peak Temperature (<math>T_p</math>)</b>		8 minutes Max.
<b>Do not exceed</b>		260°C

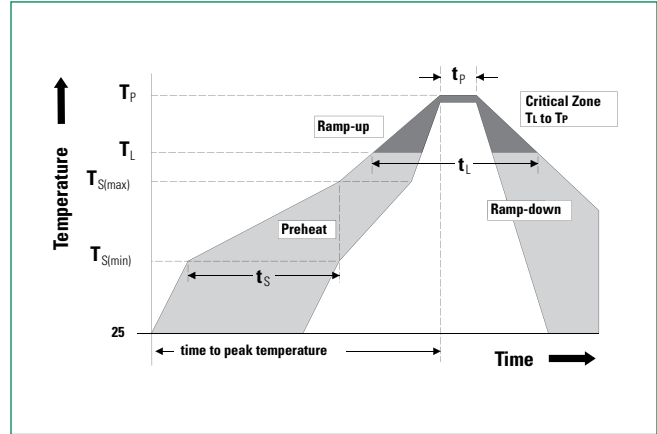

### Part Numbering System

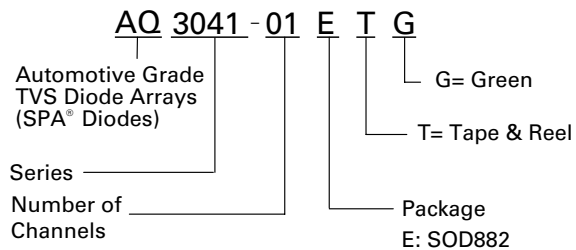

### Product Characteristics

<b>Lead Plating</b>	Pre-Plated Frame
<b>Lead Material</b>	Copper Alloy
<b>Substrate material</b>	Silicon
<b>Body Material</b>	Molded Compound
<b>Flammability</b>	UL Recognized compound meeting flammability rating V-0

### Ordering Information

Part Number	Package	Min. Order Qty.
AQ3041-01ETG	SOD882	10000

### Part Marking System

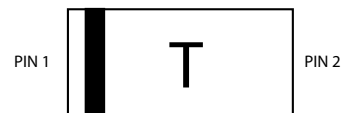

# AQ3041 Series

## Low Capacitance ESD Protection

### Package Dimensions – SOD882

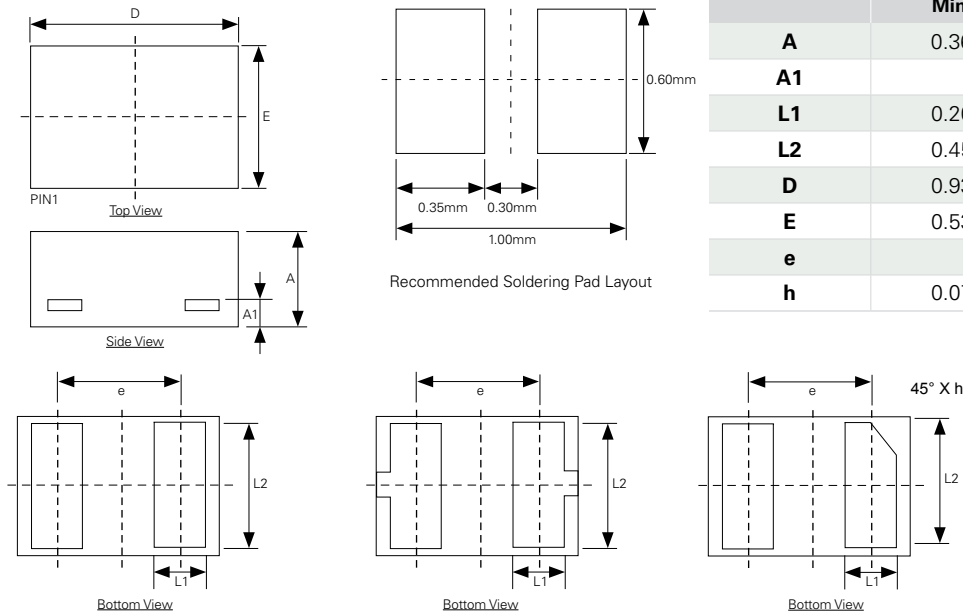

Symbol	DIMENSIONS (mm)		
	Min.	Nor.	Max.
A	0.36	0.45	0.55
A1	0.127 REF		
L1	0.20	0.25	0.30
L2	0.45	0.50	0.55
D	0.93	1.00	1.07
E	0.53	0.60	0.67
e	0.65 BSC		
h	0.07	0.12	0.17

### Embossed Carrier Tape & Reel Specification – SOD882

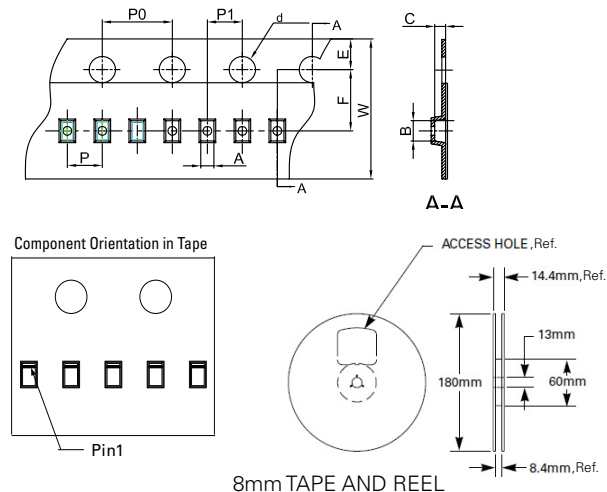

Symbol	Millimetres		Inches	
	Min	Max	Min	Max
A	0.65	0.70	0.026	0.028
B	1.10	1.20	0.043	0.047
C	0.50	0.60	0.020	0.024
d $\varnothing$	1.40	1.60	0.055	0.063
E	1.65	1.85	0.065	0.073
F	3.40	3.60	0.134	0.142
P0	3.90	4.10	0.154	0.161
P	1.90	2.10	0.075	0.083
P1	1.90	2.10	0.075	0.083
W	7.90	8.10	0.311	0.319

**Disclaimer Notice** - Information furnished is believed to be accurate and reliable. However, users should independently evaluate the suitability of and test each product selected for their own applications. Littelfuse products are not designed for, and may not be used in, all applications. Read complete Disclaimer Notice at <http://www.littelfuse.com/disclaimer-electronics>.