

# Midget 10x38mm Fuses

## FLQ Series

500 V ac • Time-Delay • 1/10–30 A



### Description

The FLQ series 500 V fuses are designed to provide supplemental overcurrent protection of control power transformers, solenoids, and circuits with high in-rush currents. They also provide excellent supplemental protection of small motors. These time-delay fuses can carry an overload several times the normal load for a short period of time without blowing. The FLQ fuses are non-indicating and may be used with an indicating fuse block to identify a blown fuse. Note that UL and CSA 500 V ratings permit use on 480 V circuits.

### Features & Benefits

FEATURES	BENEFITS
<b>10x38 mm size</b>	Common dimensions used in a variety of applications
<b>Time-delay</b>	Allows for temporary current surge for a short period of time without blowing
<b>POWR-GARD® technology</b>	Ensures quality backup overcurrent protection

### Applications

- Control circuit transformers
- Solenoids
- Circuits with high in-rush currents
- Small motors

# Midget 10x38mm Fuses

## FLQ Series

### Specifications

<b>Voltage Rating</b>	Ac: 500 V ac or less Dc: 300 V
<b>Interrupting Ratings</b>	Ac: 10 kA rms symmetrical Dc: 10 kA self-certified
<b>Ampere Range</b>	$\frac{1}{10}$ –30 A
<b>Applicable Standards</b>	Ac: UL Listed (File: E10480) CSA Certified (File: LR29862) Dc: Littelfuse self-certified
<b>Environmental</b>	RoHS Compliant
<b>Material</b>	Body: Paper: $\frac{1}{10}$ A–5 A Melamine: 5 $\frac{1}{10}$ A–30 A Caps: Copper Alloy (Nickel plated)
<b>Country of Origin</b>	Mexico

### Certification & Compliance

<b>UL</b>	UL Listed (File: E10480)
<b>CSA</b>	CSA Certified (File: LR29862)
<b>CE</b>	EU_DOC-FLQ_210701
<b>RoHS</b>	RoHS 2 Directive 2011/65/EU; Directive (EU) 2015/863

### Accessories

Littelfuse LPSM dead-front series fuse holder  
Littelfuse L60030M open-face series fuse holder

### Ordering Information

#### Ferrule Version

AMP RATING	VOLTAGE (V AC)	INTERRUPTING RATING (KA)		CATALOG NUMBER	PRODUCT MARKING	ORDERING NUMBER	UPC	AGENCY APPROVALS	
		AC	DC					UL	CSA
$\frac{1}{10}$	500	10	10	FLQ.100	FLQ $\frac{1}{10}$ A	0FLQ.100T	07945816011	•	•
$\frac{1}{8}$	500	10	10	FLQ.125	FLQ $\frac{1}{8}$ A	0FLQ.125T	07945816012	•	•
$\frac{1}{4}$	500	10	10	FLQ.150	FLQ $\frac{1}{4}$ A	0FLQ.150T	07945816013	•	•
$\frac{3}{16}$	500	10	10	FLQ.187	FLQ $\frac{3}{16}$ A	0FLQ.187T	07945816017	•	•
$\frac{1}{4}$	500	10	10	FLQ.200	FLQ $\frac{1}{4}$ A	0FLQ.200T	07945816018	•	•
$\frac{3}{8}$	500	10	10	FLQ.250	FLQ $\frac{3}{8}$ A	0FLQ.250T	07945816019	•	•
$\frac{1}{2}$	500	10	10	FLQ.300	FLQ $\frac{1}{2}$ A	0FLQ.300T	07945800089	•	•
$\frac{3}{4}$	500	10	10	FLQ.400	FLQ $\frac{3}{4}$ A	0FLQ.400T	07945816023	•	•
$\frac{1}{2}$	500	10	10	FLQ.500	FLQ $\frac{1}{2}$ A	0FLQ.500T	07945816024	•	•
$\frac{3}{4}$	500	10	10	FLQ.600	FLQ $\frac{3}{4}$ A	0FLQ.600T	07945800090	•	•
$\frac{3}{4}$	500	10	10	FLQ.800	FLQ $\frac{3}{4}$ A	0FLQ.800T	07945800091	•	•
1	500	10	10	FLQ001	FLQ 1A	0FLQ001.T	07945816031	•	•
1 $\frac{1}{8}$	500	10	10	FLQ1.12	FLQ 1- $\frac{1}{8}$ A	0FLQ1.12T	07945816032	•	•
1 $\frac{1}{4}$	500	10	10	FLQ1.25	FLQ 1- $\frac{1}{4}$ A	0FLQ1.25T	07945816034	•	•

# Midget 10x38mm Fuses

## FLQ Series

### Ordering Information

#### Ferrule Version

AMP RATING	VOLTAGE (V AC)	INTERRUPTING RATING (KA)		CATALOG NUMBER	PRODUCT MARKING	ORDERING NUMBER	UPC	AGENCY APPROVALS	
		AC	DC					UL	CSA
1 ½	500	10	10	FLQ01.5	FLQ 1-½A	OFLQ01.5T	07945816037	•	•
1 ⅝	500	10	10	FLQ01.6	FLQ 1-⅝A	OFLQ01.6T	07945816038	•	•
2	500	10	10	FLQ002	FLQ 2A	OFLQ002.T	07945816041	•	•
2 ¼	500	10	10	FLQ2.25	FLQ 2-¼A	OFLQ2.25T	07945816042	•	•
2 ½	500	10	10	FLQ02.5	FLQ 2-½A	OFLQ02.5T	07945816043	•	•
3	500	10	10	FLQ003	FLQ 3A	OFLQ003.T	07945816047	•	•
3 ⅝	500	10	10	FLQ03.2	FLQ 3-⅝A	OFLQ03.2T	07945816049	•	•
3 ½	500	10	10	FLQ03.5	FLQ 3-½A	OFLQ03.5T	07945816051	•	•
4	500	10	10	FLQ004	FLQ 4A	OFLQ004.T	07945816053	•	•
4 ½	500	10	10	FLQ04.5	FLQ 4-½A	OFLQ04.5T	07945816054	•	•
5	500	10	10	FLQ005	FLQ 5A	OFLQ005.T	07945816055	•	•
5 ⅝	500	10	10	FLQ05.6	FLQ 5-⅝A	OFLQ05.6T	07945816056	•	•
6	500	10	10	FLQ006	FLQ 6A	OFLQ006.T	07945816058	•	•
6 ¼	500	10	10	FLQ6.25	FLQ 6-¼A	OFLQ6.25T	07945816059	•	•
7	500	10	10	FLQ007	FLQ 7A	OFLQ007.T	07945816061	•	•
8	500	10	10	FLQ008	FLQ 8A	OFLQ008.T	07945816063	•	•
9	500	10	10	FLQ009	FLQ 9A	OFLQ009.T	07945816064	•	•
10	500	10	10	FLQ010	FLQ 10A	OFLQ010.T	07945816065	•	•
12	500	10	10	FLQ012	FLQ 12A	OFLQ012.T	07945816066	•	•
14	500	10	10	FLQ014	FLQ 14A	OFLQ014.T	07945816067	•	•
15	500	10	10	FLQ015	FLQ 15A	OFLQ015.T	07945816068	•	•
20	500	10	10	FLQ020	FLQ 20A	OFLQ020.T	07945816071	•	•
25	500	10	10	FLQ025	FLQ 25A	OFLQ025.T	07945816072	•	•
30	500	10	10	FLQ030	FLQ 30A	OFLQ030.T	07945816073	•	•

### Ordering Information

#### PCB Mount 1-Tab Version

AMP RATING	VOLTAGE (V AC)	INTERRUPTING RATING (KA)		CATALOG NUMBER	PRODUCT MARKING	ORDERING NUMBER	UPC	AGENCY APPROVALS	
		AC	DC					UL	CSA
1 <sup>5</sup> / <sub>100</sub>	500	10	10	FLQ.150R	FLQ 1 <sup>5</sup> / <sub>100</sub> A-R	OFLQ.150HXR	07945894950	•	•
⅓ <sub>16</sub>	500	10	10	FLQ.187R	FLQ ⅓ <sub>16</sub> A-R	OFLQ.187HXR	07945894951	•	•
⅓ <sub>10</sub>	500	10	10	FLQ.200R	FLQ ⅓ <sub>10</sub> A-R	OFLQ.200HXR	07945894952	•	•
¼	500	10	10	FLQ.250R	FLQ ¼A-R	OFLQ.250HXR	07945894953	•	•
⅓ <sub>10</sub>	500	10	10	FLQ.300R	FLQ ⅓ <sub>10</sub> A-R	OFLQ.300HXR	07945894954	•	•
⅓ <sub>10</sub>	500	10	10	FLQ.400R	FLQ ⅓ <sub>10</sub> A-R	OFLQ.400HXR	07945894955	•	•
½	500	10	10	FLQ.500R	FLQ ½A-R	OFLQ.500HXR	07945894956	•	•
⅔ <sub>10</sub>	500	10	10	FLQ.600R	FLQ ⅔ <sub>10</sub> A-R	OFLQ.600HXR	07945894957	•	•
⅔ <sub>10</sub>	500	10	10	FLQ.800R	FLQ ⅔ <sub>10</sub> A-R	OFLQ.800HXR	07945894958	•	•

# Midget 10x38mm Fuses

## FLQ Series

### Ordering Information

#### PCB Mount 1-Tab Version

AMP RATING	VOLTAGE (V AC)	INTERRUPTING RATING (KA)		CATALOG NUMBER	PRODUCT MARKING	ORDERING NUMBER	UPC	AGENCY APPROVALS	
		AC	DC					UL	CSA
1	500	10	10	FLQ001R	FLQ 1A-R	OFLQ001.HXR	07945894959	•	•
1 1/8	500	10	10	FLQ1.12R	FLQ 1 1/8A-R	OFLQ1.12HXR	07945894981	•	•
1 1/4	500	10	10	FLQ1.25R	FLQ 1 1/4A-R	OFLQ1.25HXR	07945894982	•	•
1 1/2	500	10	10	FLQ01.5R	FLQ 1 1/2A-R	OFLQ01.5HXR	07945894967	•	•
1 3/10	500	10	10	FLQ01.6R	FLQ 1 3/10A-R	OFLQ01.6HXR	07945894968	•	•
2	500	10	10	FLQ002R	FLQ 2A-R	OFLQ002.HXR	07945894960	•	•
2 1/4	500	10	10	FLQ2.25R	FLQ 2 1/4A-R	OFLQ2.25HXR	07945894983	•	•
2 1/2	500	10	10	FLQ02.5R	FLQ 2 1/2A-R	OFLQ02.5HXR	07945894973	•	•
3	500	10	10	FLQ003R	FLQ 3A-R	OFLQ003.HXR	07945894961	•	•
3 3/10	500	10	10	FLQ03.2R	FLQ 3 3/10A-R	OFLQ03.2HXR	07945894976	•	•
3 1/2	500	10	10	FLQ03.5R	FLQ 3 1/2A-R	OFLQ03.5HXR	07945894977	•	•
4	500	10	10	FLQ004R	FLQ 4A-R	OFLQ004.HXR	07945894962	•	•
4 1/2	500	10	10	FLQ04.5R	FLQ 4 1/2A-R	OFLQ04.5HXR	07945894979	•	•
5	500	10	10	FLQ005R	FLQ 5A-R	OFLQ005.HXR	07945894963	•	•
5 5/10	500	10	10	FLQ05.6R	FLQ 5 5/10A-R	OFLQ05.6HXR	07945894980	•	•
6 1/4	500	10	10	FLQ6.25R	FLQ 6 1/4A-R	OFLQ6.25HXR	07945894984	•	•
7	500	10	10	FLQ007R	FLQ 7A-R	OFLQ007.HXR	07945894964	•	•
8	500	10	10	FLQ008R	FLQ 8A-R	OFLQ008.HXR	07945894965	•	•
9	500	10	10	FLQ009R	FLQ 9A-R	OFLQ009.HXR	07945894966	•	•
10	500	10	10	FLQ010R	FLQ 10A-R	OFLQ010.HXR	07945894969	•	•
12	500	10	10	FLQ012R	FLQ 12A-R	OFLQ012.HXR	07945807768	•	•
14	500	10	10	FLQ014R	FLQ 14A-R	OFLQ014.HXR	07945894971	•	•
15	500	10	10	FLQ015R	FLQ 15A-R	OFLQ015.HXR	07945894972	•	•
20	500	10	10	FLQ020R	FLQ 20A-R	OFLQ020.HXR	07945894974	•	•
25	500	10	10	FLQ025R	FLQ 25A-R	OFLQ025.HXR	07945894975	•	•
30	500	10	10	FLQ030R	FLQ 30A-R	OFLQ030.HXR	07945894978	•	•

# Midget 10x38mm Fuses

## FLQ Series

### Dimensions Millimeters (inches)

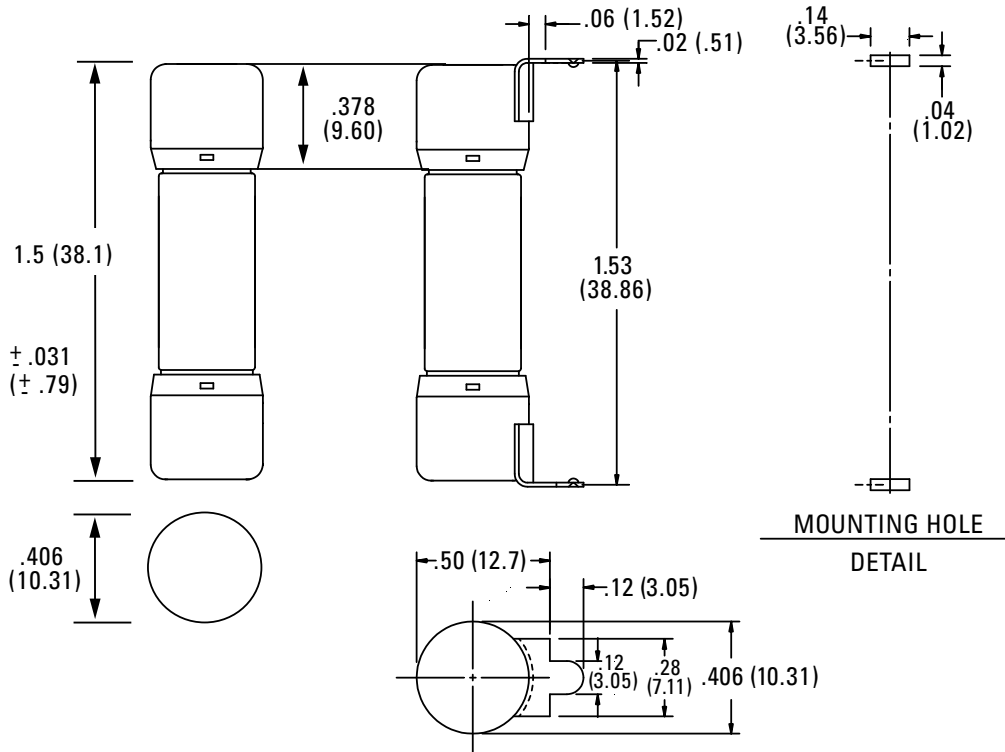

### Temperature Derating Curve

Ambient temperature: temperature of air immediately surrounding fuse

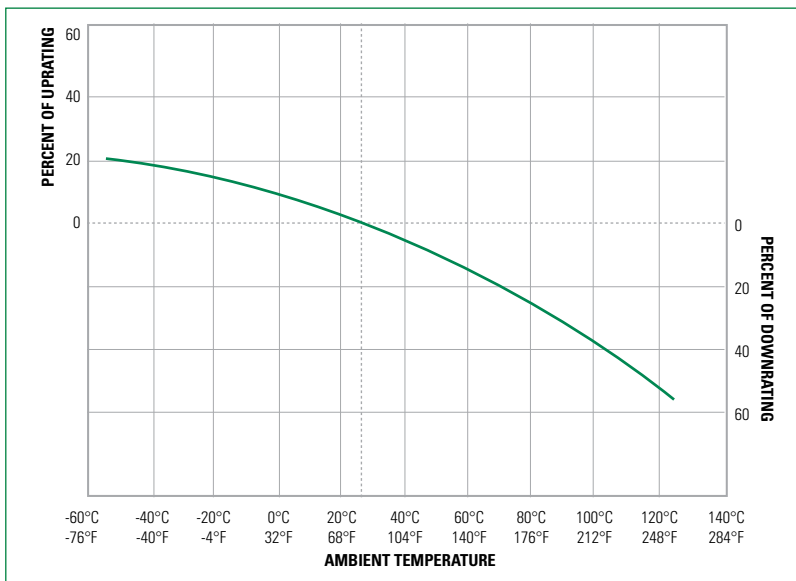

# Midget 10x38mm Fuses

## FLQ Series

### Time Current Curves

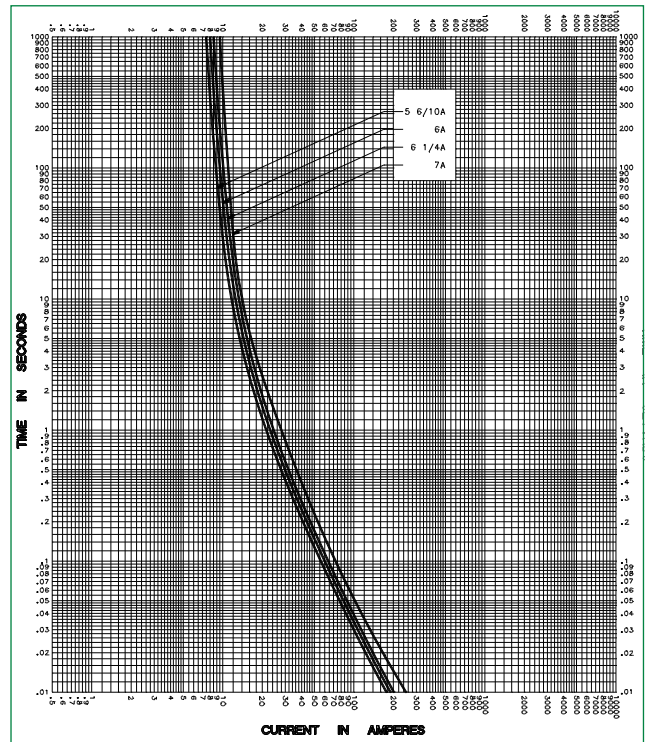
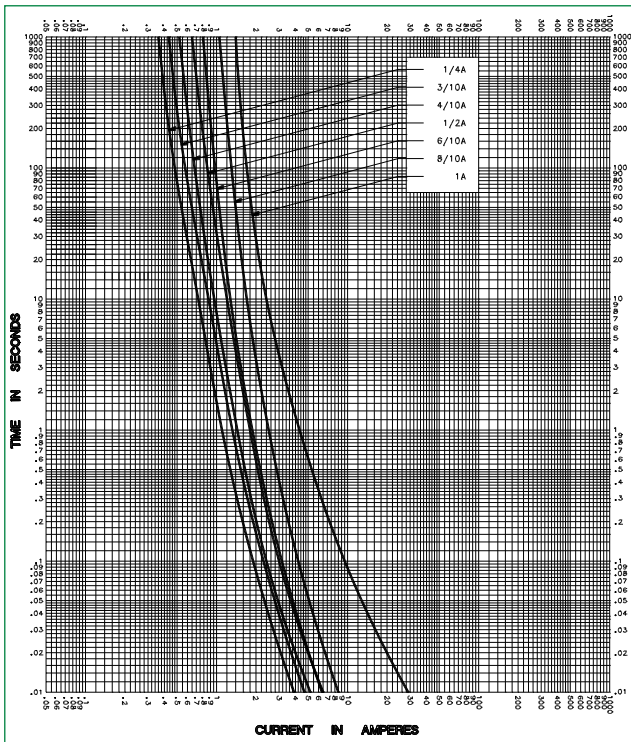
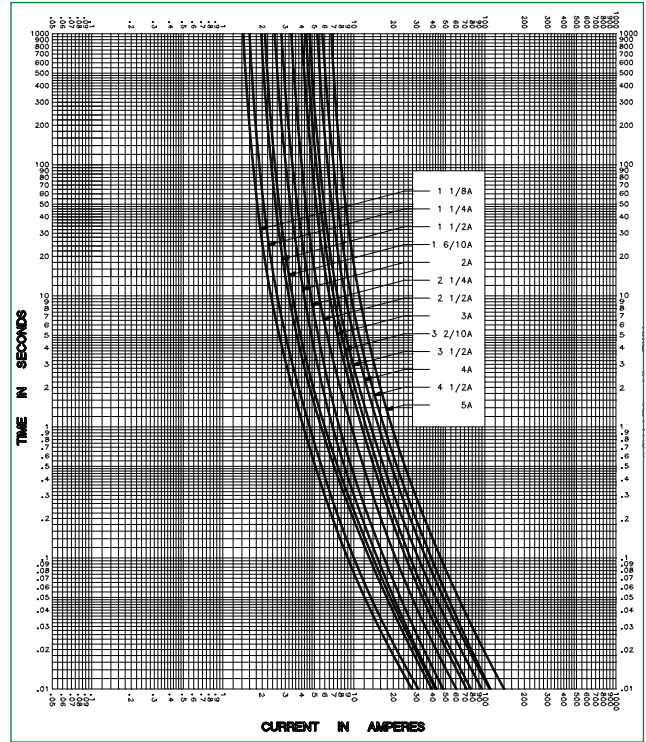
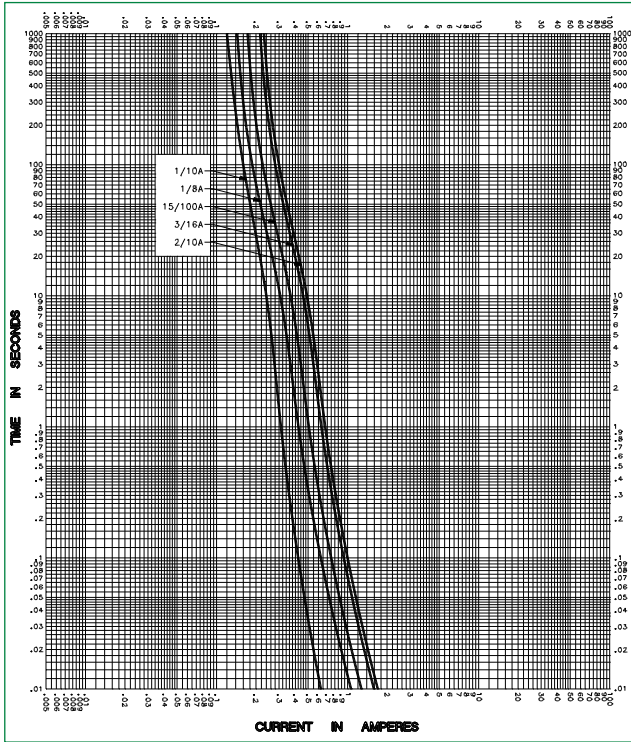

# Midget 10x38mm Fuses

## FLQ Series

### Time Current Curves

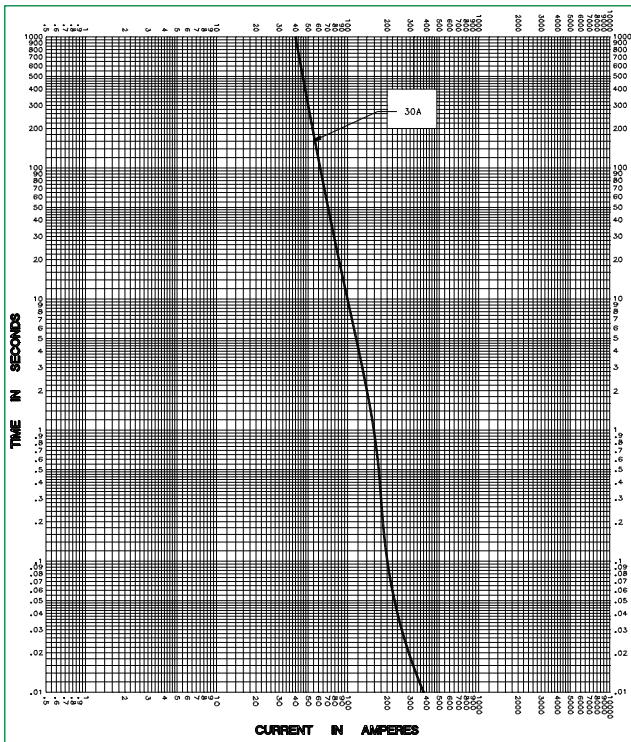
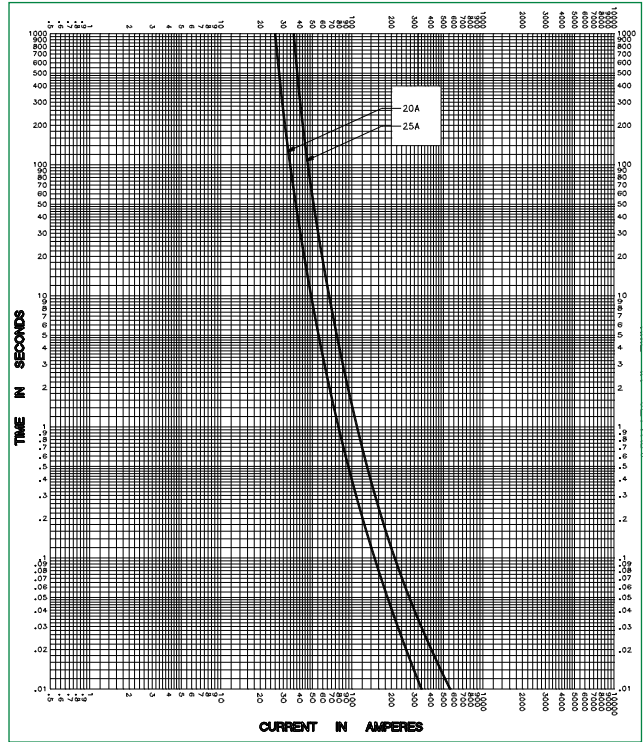
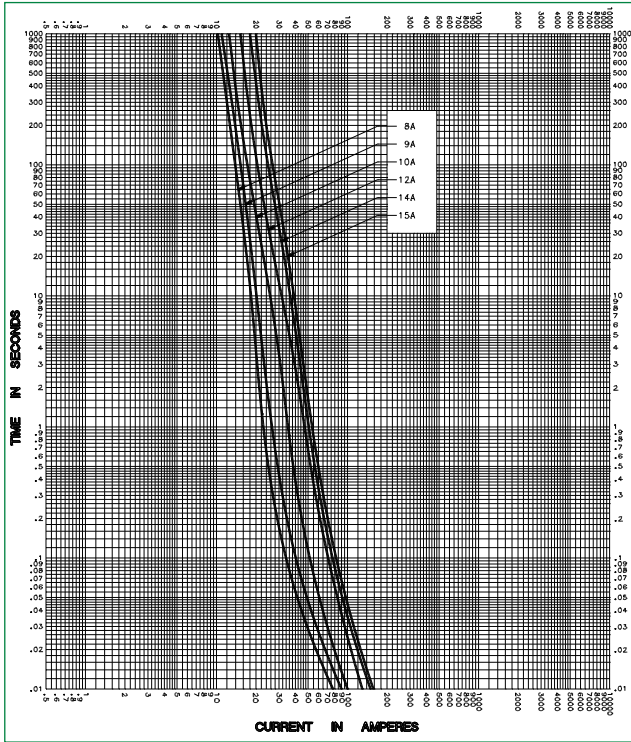

**Disclaimer Notice** – Information furnished is believed to be accurate and reliable. However, users should independently evaluate the suitability of and test each product selected for their own applications. Littelfuse products are not designed for, and may not be used in, all applications. Read complete Disclaimer Notice at [www.littelfuse.com/product-disclaimer](http://www.littelfuse.com/product-disclaimer).